

ORIGINAL

BEC 75

Assembly &
operating
instructions

PLUMBING

General Installation:

Internal plumbing should be galvanised $\frac{1}{2}$ " or $\frac{3}{4}$ " piping. Plastic piping may be used but well supported, as sagging can cause air locks. Connect Waterers to the piping with the Saddle Connector supplied. Drill a $\frac{9}{32}$ " or $\frac{5}{16}$ " hole into the piping and place the Saddle Clamp over. Do not overtighten the Saddle Clamp as this may create distortion and leakage.

Although the B.E.C. 75 is fitted with its own filter element, a line filter in each house installation is recommended.

The B.E.C. 75 is designed to work on a low pressure water supply, that is below 5 p.s.i. (.35 bar). Ideally the supply should be from a header tank 8-12 ft. above the ground.

ASSEMBLY

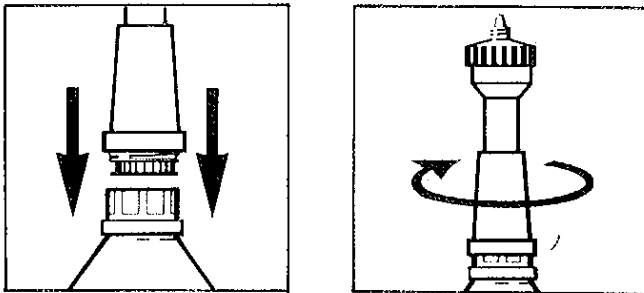

Insert the black valve unit into the top of the cone, valve downwards. Push the black adjuster collar down until it locates into the threads. **Care must be taken not to cross the threads.** Continue screwing in a clockwise direction until the ratchet is reached. Normally, eight clicks give a starting point for adjustment. Level can then be controlled by rotating the adjuster collar, clockwise for more depth, anti-clockwise for less.

2 TUBE CONNECTIONS

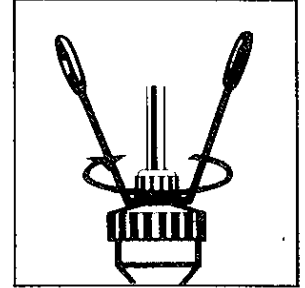
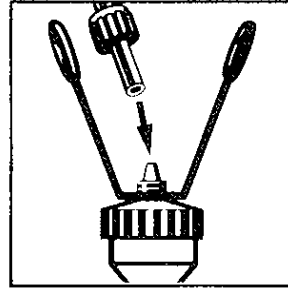

Place a nut, thread outwards, onto the end of the tube. Push Hanger Strap over filter top. Push the tube onto the tapered end of the filter top as far as it will go. Tighten the nut firmly. Repeat at the Saddle Connector end.

3 SUSPENSION

Tie a looped knot in one end of the hanging cord. Pass the other end through one eye of the Slider, then through the small eye of the Tube Hook, then through both eyes of the Hanger Strap. Finally, pass this end back up to the Slider, and knot it through the remaining eye. The B.E.C. 75 is suspended by this cord from the looped knot end. (SEE SUSPENSION DIAGRAM OVERLEAF)

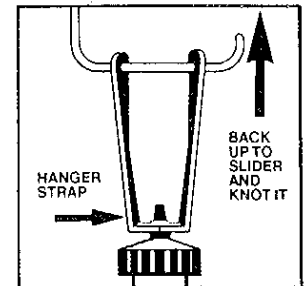
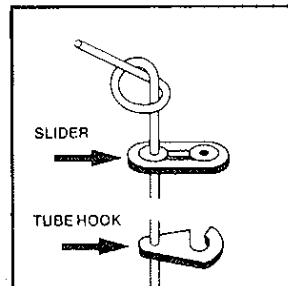

For the most efficient operation, it is necessary to suspend the Waterers above the height of the backs of the birds. With large birds and Layers the Waterers should be set at about their eye level.

BEC 75

OPERATION

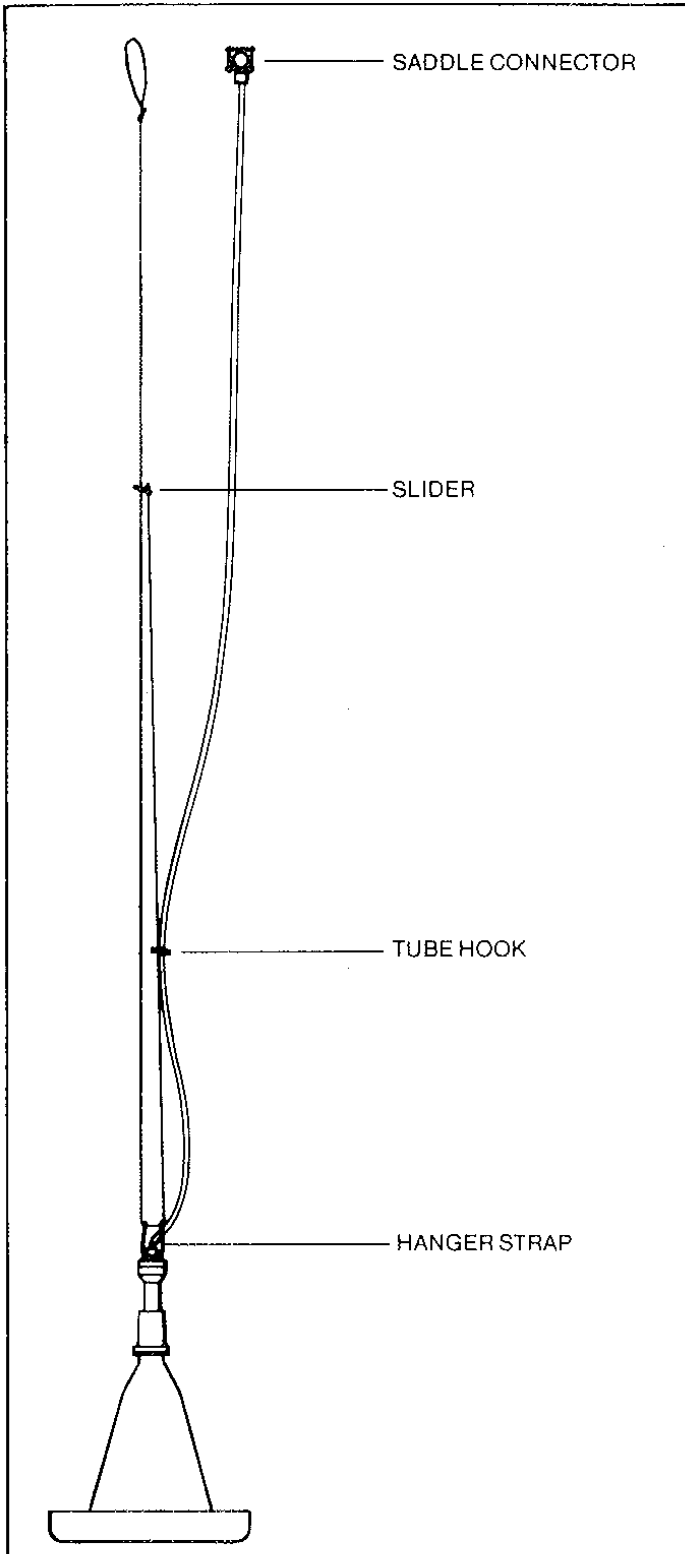

PARTS LIST

KEY

- 412747 - SADDLE CONNECTOR COMPRESSION
- (Part of 412747) - TUBE HOOK
- 412787 - WATERMASTER TUBING NEW
- 411455 - 1/4" BSP NUT
- 412767 - FILTER TOP COMPRESSION
- 411777 - FILTER DISC
- 411782 - STEM
- 413114 - ADJUSTER COLLAR
- 411802 - MAIN SPRING
- 411596 - VALVE SPRING
- 411817 - VALVE WASHER
- 412988 - VALVE SEATING BEC 75
- 413109 - CONE BEC 75
- 411898 - HANGER STRAP
- 411481 - SLIDER
- 413430 - ANTI SPLASH RING
- 411496 - CORD PLASTIC COVERED

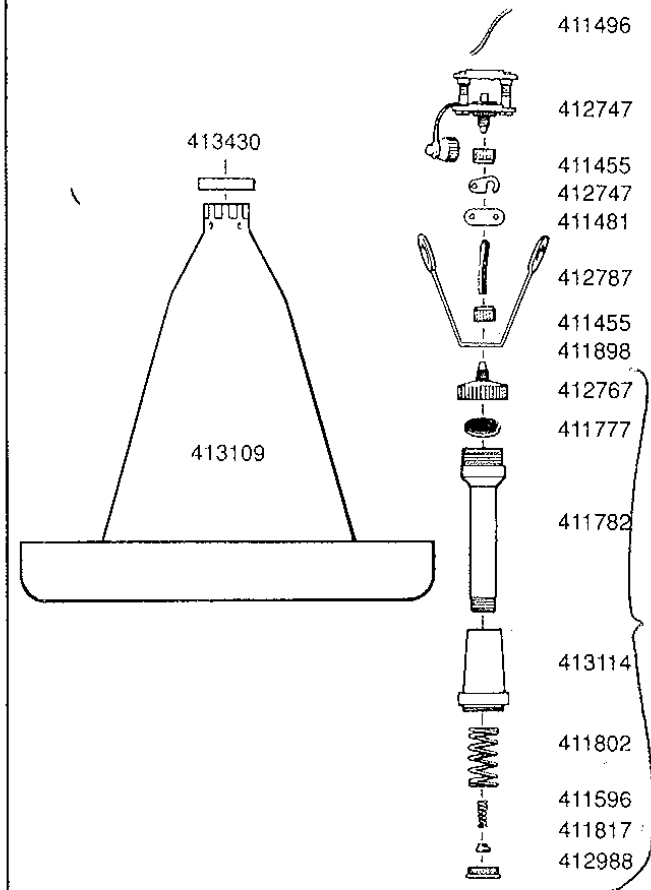

41275VA

Valve assembly & stem